

OPERATING INSTRUCTIONS

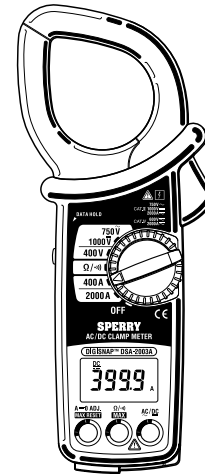

**DSA-2003A
DIGITAL AC/DC CLAMP METER**

A.W. SPERRY INSTRUMENTS INC.
The Professional's Choice®

2150 Joshua's Path, Suite 302, Hauppauge, NY 11788
Phone: 1-800-645-5398 or 631-231-7050
Fax: 631-434-3128 • Email: cat@awsperry.com
www.awsperry.com

A.W. SPERRY INSTRUMENTS INC.
The Professional's Choice®

Contents

1 . Safety Warnings	1
2 . Features	5
3 . Specifications	6
4 . Instrument Layout	9
5 . Preparation for Measurement	12
6 . Measurement	
6 - 1 DC Current Measurement	13
6 - 2 AC Current Measurement	15
6 - 3 DC Voltage Measurement	16
6 - 4 AC Voltage Measurement	17
6 - 5 Resistance Measurement	18
6 - 6 Continuity Check	19
6 - 7 MAX Measurement	20
7 . Other Functions	
7 - 1 Sleep Function	21
7 - 2 Data Hold Function	22
7 - 3 OUTPUT Terminal	23
8 . Battery Replacement	25

1 . Safety Warnings

This instrument has been designed, manufactured and tested according to IEC 61010: Safety requirements for Electronic Measuring apparatus, and delivered in the best condition after passed the inspection. This instruction manual contains warnings and safety procedures which have to be observed to ensure safe operation of the instrument and maintain it in a safe condition. Thus, these operating instructions have to be read prior to using the instrument.

⚠ WARNING

Read through and understand instructions contained in this manual before starting using the instrument.

Save and keep the manual handy to enable quick reference whenever necessary.

Be sure to use the instrument only in its intended applications and to follow measurement procedures described in the manual.

Be sure to understand and follow all safety instructions contained in the manual.

Failure to follow the above instructions may cause injury, instrument damage and/or damage to equipment under test

The symbol \triangle indicated on the instrument means that the user must refer to related parts in the manual for safe operation of the instrument. Be sure to carefully read the instructions following each \triangle symbol in this manual.

- \triangle DANGER is reserved for conditions and actions that are likely to cause serious or fatal injury.
- \triangle WARNING is reserved for conditions and actions that can cause serious or fatal injury.
- \triangle CAUTION is reserved for conditions and actions that can cause minor injury or instrument damage.

Following symbols are used on the instrument and in the instruction manual. Attention should be paid to each symbol to ensure your safety.

\triangle	This symbol is marked where the user must refer to the instruction manual so as not to cause personal injury or instrument damage.
\square	Indicates an instrument with double or reinforced insulation.
\square	Indicates that this instrument can clamp on bare conductors when measuring a voltage corresponding to the applicable Measurement category, which is marked next to this symbol.
~	Indicates AC (Alternating Current).
=	Indicates DC (Direct Current).
\approx	Indicates AC and DC.

\triangle DANGER

Never make measurement on a circuit in the following categories;
 Measurement category (CAT.) : over AC/DC600V
 Measurement category (CAT.) or lower: over AC750V/DC1000V
 Do not make measurement when thunder is rumbling. Stop measurement and take off the instrument from the object under test. Do not attempt to make measurement in the presence of flammable gasses, fumes, vapor or dust. Otherwise, the use of the instrument may cause sparking, which can lead to an explosion.
 The transformer jaws are made of metal and their tips are not insulated. Where equipment under test has exposed conductive parts, be especially careful about the hazard of possible shorting. Not following this instruction may can danger to the user.
 Never attempt to use the instrument if its surface or your hand is wet. Do not exceed the maximum allowable input of any measurement range. Never open the battery compartment cover when making measurement. Never try to make measurement if any abnormal conditions, such as broken Transformer jaws or case is noted.
 To avoid electrical shock by touching the equipment under test or its surroundings, be sure to wear insulated protective gear.
 The instrument is to be used only in its intended applications or conditions. Otherwise, safety functions equipped with the instrument doesn't work, and instrument damage or serious personal injury may be caused.

\triangle WARNING

Never attempt to make any measurement, if the instrument has any structural abnormality such as cracked case and exposed metal part. Do not turn the Function Selector switch with test leads connected to the instrument.
 Do not install substitute parts or make any modification to the instrument. Return the instrument to your distributor for repair or re-calibration.
 Do not try to replace the batteries if the surface of the instrument is wet. Always switch off the instrument before opening the battery compartment cover for battery replacement.
 Always be sure to keep your fingers and hands behind the Safety barrier. (see of **4. Instrument Layout**) Otherwise, user may be exposed to the danger of electrical shock.

⚠ CAUTION

Make sure that the Function Selector switch is set to an appropriate position before making measurement.

Always make sure to insert each plug of the test leads fully into the appropriate terminal on the instrument.

Be sure to set the Function Selector switch to the "OFF" position after use. When the instrument will not be in use for a long period of time, place it in storage after removing the batteries.

Do not expose the instrument to the direct sun, extreme temperatures or dew fall.

Use a damp cloth and detergent for cleaning the instrument. Do not use abrasives or solvents.

Take sufficient care not to apply shock such as drop. Otherwise, precisely adjusted Transformer jaws will be damaged.

Be careful not to pinch some foreign substances with the Transformer jaw tips.

Measurement categories(Over-voltage categories)

To ensure safe operation of measuring instruments, IEC 61010 establishes safety standards for various electrical environments, categorized as CAT to CAT , and called measurement categories. Higher-numbered categories correspond to electrical environments with greater momentary energy, so a measuring instrument designed for CAT environments can endure greater momentary energy than one designed for CAT

- CAT. : Secondary electrical circuits connected to an AC electrical outlet through a transformer or similar device.
- CAT. : Primary electrical circuits of equipment connected to an AC electrical outlet by a power cord.
- CAT. : Primary electrical circuits of the equipment connected directly to the distribution panel, and feeders from the distribution panel to outlets.
- CAT. : The circuit from the service drop to the service entrance, and to the power meter and primary over-current protection device (distribution panel).

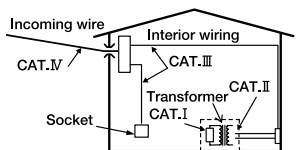

4

2 . Features

Tear-drop-shaped jaws for ease of use in crowded cable areas and other tight places

Provides a wide measuring range from 0 up to 2000A

Terminal cover to avoid the use of incorrect use of the input terminals.

MAX measurement function for easy reading of maximum input over a certain period of time

Output terminal for long term current monitoring

Safety design throughout conforming to the following provisions of IEC61010

Pollution degree 2, overvoltage category 600V

Pollution degree 2, overvoltage category 1000V

Data hold function to allow for easy readings in dimly lit or hard-to-read locations.

Sleep feature to conserve battery power.

Permits easy continuity check with a beeper

Provides a dynamic range of 4,000 counts full scale

Wide frequency range from 40Hz to 1kHz

Transformer jaws fitted will guard to further improve safety

5

3 . Specifications

Measuring Ranges and Accuracy (at 23 ± 5 , 45 to 85%RH)

DC Current $\overline{\text{—}}$

Range	Measuring Ranges	Accuracy
400A	0 to ± 400.0A	± 1.5%rdg ± 2dgt
2000A	0 to ± 2000A	

AC Current \sim

Range	Measuring Ranges	Accuracy
400A	0 to 400.0A	± 1.5%rdg ± 2dgt(50/60Hz)
		± 3.0%rdg ± 4dgt(40 ~ 500Hz)
2000A	0 to 1000A	± 5.0%rdg ± 4dgt(500 ~ 1kHz)
		± 1.5%rdg ± 2dgt(50/60Hz)
	1001 to 2000A	± 3.0%rdg ± 4dgt(40 ~ 500Hz)
		± 5.0%rdg ± 4dgt(500 ~ 1kHz)
		± 3.0%rdg ± 2dgt(50/60Hz)

DC Voltage(Input impedance:2M) $\overline{\text{—}}$

Range	Measuring Ranges	Accuracy
400V	0 to ± 400.0V	± 1.0%rdg ± 2dgt
1000V	0 to ± 1000V	

AC Voltage(Input impedance:2M) \sim

Range	Measuring Ranges	Accuracy
400V	0 to 400.0V	± 1.5%rdg ± 2dgt(50/60Hz)
750V	0 to 750V	± 1.5%rdg ± 4dgt(40 ~ 1kHz)

Resistance(Auto-ranging)

Range	Measuring Ranges	Accuracy
400 / 4000	0 to 4000	± 1.5%rdg ± 2dgt

Resistance(Fixed)

Range	Measuring Ranges	Accuracy
400	0 ~ 400.0	± 1.5%rdg ± 2dgt(Buzzer beeps at 50 ± 35 of less)

OUTPUT Voltage(Output impedance: about 10k)

Range	DC Output Voltages	Input Currents	Accuracy	
DC	400A	0 to 400.0mV	0 to 400A	± 1.5%rdg ± 3mV
	2000A	0 to 200.0mV	0 to 2000A	± 1.5%rdg ± 3mV
AC	400A	0 to 400.0mV	0 to 400A	± 1.5%rdg ± 3mV(50/60Hz)
				± 3.0%rdg ± 3mV(40 ~ 500Hz)
	2000A	0 to 100.0mV	0 to 1000A	± 5.0%rdg ± 3mV(500 ~ 1kHz)
		100.1 to 200.0mV	1001 to 2000A	± 3.0%rdg ± 3mV(50/60Hz)

Electromagnetic compatibility (EN 61000-4-3)

:RF field strength = <=1V/m, total accuracy = specified accuracy

:RF field strength =3V/m, total accuracy = specified accuracy +1% of range

Operating System : Dual Integration

Display : Liquid crystal display with maximum counts of 4000

Low Battery Warning : "BATT" symbol is displayed on the digital display.

Overrange Indication : "OL" is displayed where input exceeds the upper limit of a range

Response Time : Approx. 2 seconds

Sample rate : Approx. 2.5 times per second

Location for use : Indoor / Outdoor use, Altitude up to 2000m

Temperature and Humidity for Guaranteed Accuracy

: 23 ± 5, relative humidity up to 85% without condensation

Operating Temperature and Humidity

: 0 to 40 , relative humidity up to 85% without condensation

Storage Temperature and Humidity

: - 20 to 60 , relative humidity up to 90% without condensation

Power Source	: Two R6P(DC1.5V) batteries or equivalent
Current Consumption	: Approx. 9mA max
Sleep function	: Automatically switches to the Sleep mode in about 10 minutes after the last switch or button operation (current consumption in the Sleep mode: about 20 μ A)
Safety Standard:	: IEC 61010-2-032 pollution degree 2 : overvoltage CAT. 600V : overvoltage CAT. 1000V EMC : EN 61326 • EN 55022 • EN 61000-4-2(performance criterion B) • EN 61000-4-3(performance criterion B)
Overload Protection	: AC/DC current ranges 2400A AC/DC for 10sec AC/DC voltage ranges 1200V AC/DC for 10sec Resistance ranges 600V AC/DC for 10sec
Withstand Voltage	: 6880V AC for 5 seconds (between electrical circuit and housing cases or metal parts of jaws)
Insulation Resistance	: 10M Ω or greater at 1000V (between electrical circuit and housing cases or , metal parts of jaws)
Conductor Size	: Approx. 55mm diameter max
Dimensions	: 250(L) \times 105(W) \times 49(D)mm
Weight	: Approx 530g
Accessories	: Test leads M-70171set : R6P batteries2 : Carrying case1 : Output Plug M-82011 : Instruction manual1

4. Instrument Layout

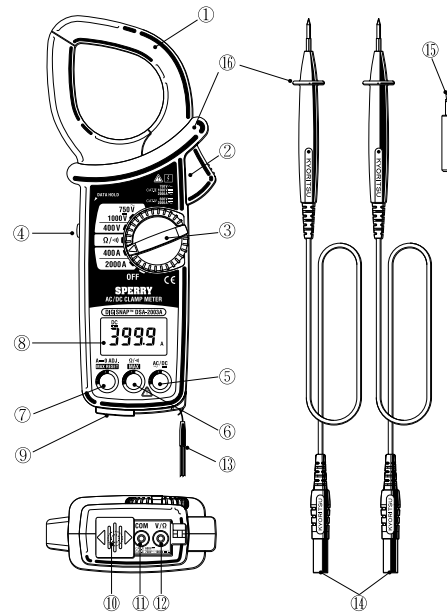

Transformer Jaws : Include current sensors

Jaw Trigger : Used to open and close the transformer jaws

Function Selector Switch

Selects function to use. Also switches off the instrument when set to the "OFF" position.

Data Hold Button

Freezes the display reading with  symbol shown on the display when pushed in.

AC/DC Button

Used to switch the instrument between the AC and DC modes. The instrument is set to the AC mode when it is powered on. Press this button to select the DC mode.

Mode Button

A press of this button on a current or voltage range turns the instrument to the MAX measurement mode with **MAX** shown on the display. Press the button again to exit the MAX mode.

A press of the button on the resistance range turns the instrument to the continuity check mode with **»** symbol shown on the display. In this mode, the buzzer beeps when the reading is about 50 Ω or less. Press the button again to exit the continuity check mode.

Zero ADJ./RESET Button

Used for zero adjustment on 400A DC range or for resetting the reading in the MAX mode. **AUTO** symbol is shown on the display when zero adjustment is enabled on 400A DC range. (Zero adjustment is available only on 400A DC range.)

LCD Display

Field effect type of liquid crystal display with maximum counts of 3999 and microprocessor-controlled annunciators and the decimal point.

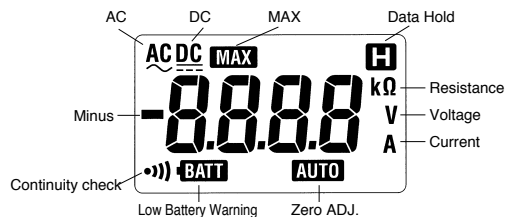

Terminal Cover

Used to enclose the input terminals (COM and V/) when the OUTPUT terminal is in use, thus avoiding accidental application of voltage to the instrument.

OUTPUT Terminal (for current measurement only)

Provides DC voltage in proportion to the reading on an AC or DC current range. The voltage is used for such purposes as long term monitoring with a recorder or other recording devices. This terminal cannot be accessed on a voltage or resistance range.

COM Terminal

Accepts the black test lead for voltage or resistance measurement.

V/ Terminal

Accepts the red test lead for voltage or resistance measurement.

Safety Hand Strap

Prevents the instrument from slipping off the hand during use.

Test Leads (M-7017)

Connect to COM and V/ Terminal terminals for resistance measurement.

Output Plug (M-8201)

Insert this plug into the OUTPUT terminal to obtain DC output voltage. Connect suitable connection cord to the plug when it is used.

Barrier

It is a part providing protection against electrical shock and ensuring the minimum required air and creepage distances.

5 . Preparation for Measurement

5-1 Checking Battery Voltage

Set the Function Selector switch to any position other than "OFF".
When the display is clear without **BATT** showing, proceed to measurement.

When the display blanks or **BATT** is shown, replace the batteries according to section 8: **Battery Replacement**

NOTE

The Sleep function automatically turns the instrument off in a certain period of time after the last switch operation. Therefore, the display may be blank with the Function Selector switch set to a position other than "OFF".

To operate the instrument in this case, set the switch back to the "OFF" position, then to the desired position, or press any button. If the display still blanks, the batteries have exhausted. Replace the batteries.

5-2 Checking Switch Setting

Make sure that the Function Selector switch is set to the correct position, the instrument is set to the correct mode and the Data Hold function is deactivated. Otherwise, desired measurement cannot be made.

6 . Measurement

6-1 DC Current Measurement

⚠ DANGER

To avoid electric shock, never make measurement on a circuit in the following categories;

Measurement category (CAT.) : over AC/DC600V

Measurement category (CAT.) or lower: over AC750V/DC1000V

Do not make measurement with the battery compartment cover removed from the instrument.

Do not make current measurement with the test leads connected to the instrument.

Keep your fingers and hands behind the barrier during measurement.

- Set the Function Selector switch to the "400A" position and press the AC/DC button to select the DC mode. "DC" should be shown on the upper left corner of the display.
- With the transformer jaws closed without clamping them onto the conductor, press the Zero ADJ. button for about one second to zero adjust the display. (The Zero ADJ button is enabled only on 400A DC range.) **AUTO** should be shown on the display.
- Set the Function Selector switch to the position appropriate for the order of the current under test.

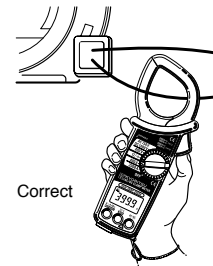

Correct

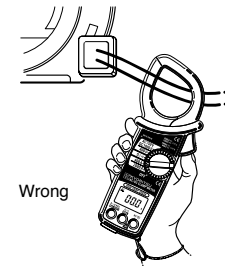

Wrong

- d. Press the trigger to open the transformer jaws and clamp them onto the conductor under test and take the reading on the display

NOTE

During current measurement, keep the transformer jaws fully closed. Otherwise, accurate measurement cannot be made. The maximum measurable conductor size is 55mm in diameter.

When the current flows from the upside (the display side) to the underside of the instrument, the polarity of the reading is positive and vice versa.

The output voltage from the OUTPUT terminal may not reduce to nil even if the display is zero adjusted with the Zero ADJ button. In this case, make zero adjustment on the recorder or other device that the output voltage is connected to.

6 - 2 AC Current Measurement

⚠ DANGER

To avoid electric shock, never make measurement on a circuit in the following categories;

Measurement category (CAT.) : over AC600V

Measurement category (CAT.) or lower: over AC750V

Do not make measurement with the battery compartment cover removed from the instrument.

Do not make current measurement with the test leads connected to the V/ and COM terminals

Keep your fingers and hands behind the barrier during measurement.

- Set the Function Selector switch to the "400A" or "2000A" position and select the AC mode. If the instrument is in the DC mode, press the AC/DC button once to select the AC mode. (The instrument is set to the AC mode when it is powered on.) "AC" should be shown on the upper left corner of the display.
- Press the trigger to open the transformer jaws and clamp them onto the conductor under test and take the reading on the display. During current measurement, keep the transformer jaws fully closed. Otherwise, accurate measurement cannot be made. The maximum measurable conductor size is 55mm in diameter. Unlike in DC current measurement, zero adjustment is not necessary in AC current measurement. There is no polarity in the reading either

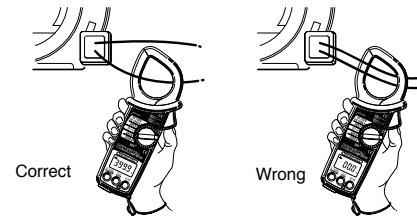

6 - 3 DC Voltage Measurement

⚠ DANGER

To avoid electric shock, never make measurement on a circuit in the following categories;

Measurement category (CAT.) : over DC600V

Measurement category (CAT.) or lower: over DC1000V

Do not make measurement with the battery compartment cover removed

Keep your fingers and hands behind the barrier during measurement.

- Set the Function Selector switch to the "400V" or "1000V" position.
- Slide the terminal cover to the left. Plug the red test lead into the V/ terminal and the black test lead into the COM terminal.
- Connect the other end of the tip of the red test lead the positive side of the circuit under test and the tip of the black test lead to the negative side. Take the reading on the display. If the test lead connection is reversed, the "—" sign is shown on the display.

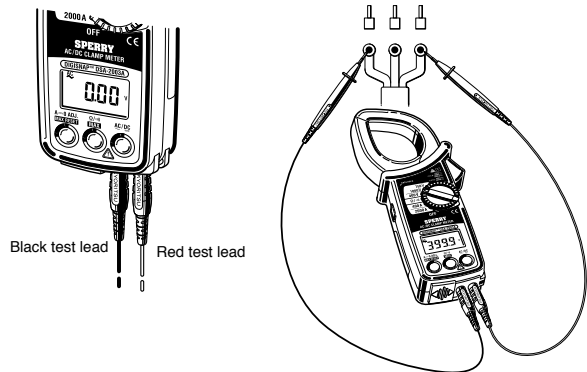

6 - 4 AC Voltage Measurement

⚠ DANGER

To avoid electric shock, never make measurement on a circuit in the following categories;

Measurement category (CAT.) : over AC600V

Measurement category (CAT.) or lower: over AC750V

Do not make measurement with the battery compartment cover removed

Keep your fingers and hands behind the barrier during measurement.

- Set the Function Selector switch to the "400V" or "750V" position. If the instrument is in the DC mode, press the AC/DC button once to select the AC mode. (The instrument is set to the AC mode when it is powered on.) The "AC" should be shown on the upper left corner of the display.
- Slide the terminal cover to the left. Plug the red test lead into the V/ terminal and the black test lead into the COM terminal.
- Connect the tip of the test leads to the circuit under test. Take the reading on the display.

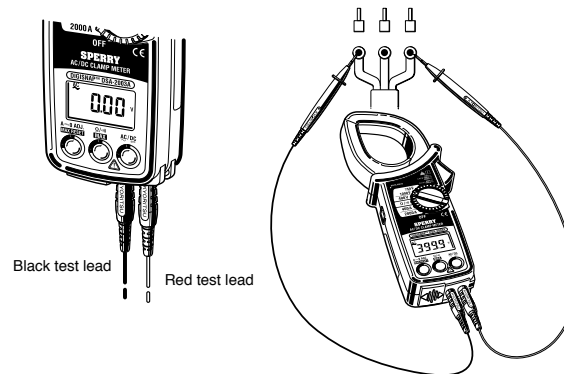

6 - 5 Resistance Measurement

⚠ DANGER

Never try to make measurement on a circuit that is not de-energized.

Do not make measurement with the battery compartment cover removed

Keep your fingers and hands behind the barrier during measurement.

- Set the Function Selector switch to the (/) position.
- Slide the terminal cover to the left. Plug the red test lead into the V/ terminal and the black test lead into the COM terminal.
- Check that the display reads "OL". Then, short the tip of the test leads together and check that the display reads "0".
- Connect the tip of the test leads to the circuit under test and take the reading on the display.

NOTE

When the tip of the test leads is shorted together, the display may read a very small resistance instead of "0". This is the resistance of the test leads, not a fault.

If one of the test leads has a break, the display reads "OL".

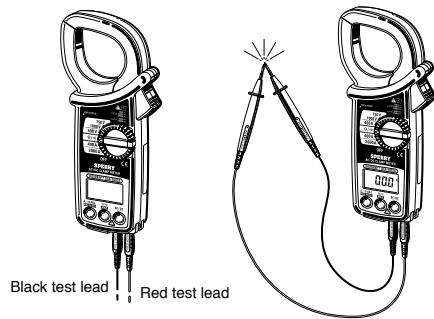

18

6-6 Continuity Check (Fixed 400 range)

⚠ DANGER

Never try to make measurement on a circuit that is not de live.

Do not make measurement with the battery compartment cover removed.

Keep your fingers and hands behind the barrier during measurement.

- Set the Function Selector switch to the (/) position.
- Slide the terminal cover to the left. Plug the red test lead into the V/ terminal and the black test lead into the COM terminal.
- Press the mode button to select the continuity check mode. The symbol should be shown on the display
- Check that the display reads "OL". Then short together the tip of the test leads and make sure that the display reads "0" and the buzzer beeps
- Connect the tip of the test leads to the circuit under test. The buzzer beeps when the resistance is about 50 or less.

NOTE

When the tip of the test leads is shorted together, the display may read a very small resistance instead of "0". This is the resistance of the test leads, not a fault.

If one of the test leads has a break, the display reads "OL".

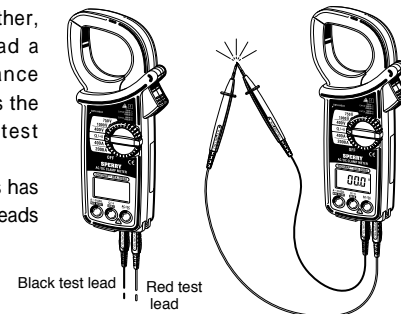

19

6 - 7 MAX Measurement (Response time: 400ms)

The MAX measurement mode is used to display a maximum reading over a certain period of time. This function is available on all ranges other than ranges.

⚠ DANGER

Never make measurement on a circuit in the following categories;
 Measurement category (CAT.) : over AC/DC600V
 Measurement category (CAT.) or lower: over AC750/DC1000V
 Do not make measurement with the battery compartment cover removed.
 Do not make measurement with the test leads connected to the instrument.
 Keep your fingers and hands behind the barrier during measurement.

- Set the Function Selector switch to the desired position.
- Press the Mode button to select the MAX measurement mode.
MAX should be shown on the display.
- In order to take a correct reading, press the Zero Adjust/Reset button once after clamping the jaws onto the conductor or connecting the test leads to the circuit under test.
- The display shows the maximum reading during measurement
- Press the Zero Adjust/Reset button once again to return to the normal measurement mode.

NOTE

Data Hold function is disabled in MAX measurement mode.
 For measurement over a period more than 10 minutes, disable the Sleep function according to the instruction in section 7-1: **Sleep Function**. Otherwise, the instrument automatically turns itself off in about 10 minutes.

7 . Other Functions

7 - 1 Sleep Function

NOTE

The instrument consumes small amount of current in the Sleep (power-down) mode. Make sure to turn the Function Selector switch to the "OFF" position, when the instrument is not in use.

This is a function to prevent the instrument from being left powered on in order to conserve battery life. This function causes the instrument to switch to the Sleep (powered-down) mode about 10 minutes after the last switch or button operation.
 To exit the Sleep mode, press any button or turn the Function Selector switch back to "OFF", then to any other position.

[How to disable the Sleep function]

Powering the instrument on with the Data Hold button pressed disables the Sleep function. "P.OFF" is shown on the display for about 3 seconds to indicate this.
 To enable the Sleep function, turn the Function Selector switch back to "OFF", then to any other position.

NOTE

The Sleep function is disabled while the output plug is inserted into the OUTPUT terminal. When the output plug is disconnected from the terminal, the Sleep function is enabled in about 10 minutes.

7 - 2 Data Hold Function

This is a function used to freeze the measured value on the display. Press the Data Hold button to freeze the reading. The reading will be held regardless of the subsequent variation of current, voltage or resistance under test.  is shown on the upper right corner of the display.

To exit the Data Hold mode, press the Data Hold button again.

NOTE

The Data Hold mode is disabled when the instrument switches to the Sleep mode.

The Data Hold function is disabled in the MAX measurement mode.

7-3 OUTPUT Terminal (For current measurement only)

⚠ DANGER

Never make measurement on a circuit in the following categories;
 Measurement category (CAT.) : over AC/DC600V
 Measurement category (CAT.) or lower: over AC750V/DC1000V
 Do not make measurement with the battery compartment cover removed.
 Never apply voltage to the OUTPUT terminal.

- a. To obtain output voltage from the OUTPUT terminal, connect a

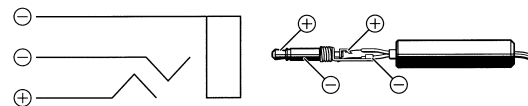

- suitable cord to the supplied output plug.
 b. Slide the terminal cover to the right to enclose the COM and V/ terminals. Insert the output plug into the OUTPUT terminal for connection with a recorder or other recording device.

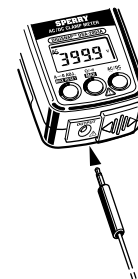

- c. Set the Function Selector switch to the "400A" or "2000A" position. (The output is available only in the two ranges.) Proceed to measurement in the DC or AC mode.

NOTE

During current measurement, keep the transformer jaws fully closed. Otherwise, accurate measurement cannot be made. The maximum measurable conductor size is 55mm in diameter.

Unlike in DC current measurement, zero adjustment is not

necessary in AC current measurement. There is no polarity in the reading either.

In the DC mode, the output voltage from the OUTPUT terminal may not reduce to nil even if the display is zero adjusted with the Zero ADJ button. In this case, make zero adjustment on the recorder or other device that the output voltage is connected to.

The Sleep function is disabled while the output plug is inserted into the OUTPUT terminal. When the output plug is disconnected from the terminal, the Sleep function is enabled in about 10 minutes.

Set the appropriate sensitivity on the recorder or other recording device. See section 3 for **output voltage specifications**.

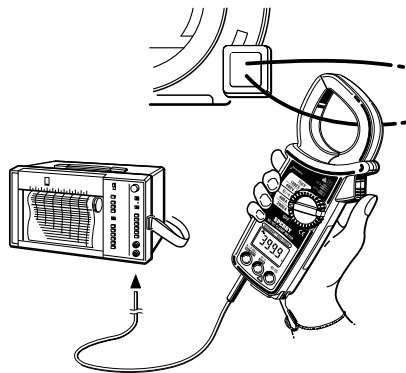

8 . Battery Replacement

⚠ WARNING

To avoid electric shock hazard, make sure to set the Function Selector switch to "OFF" and remove the test leads from the instrument before trying to replace batteries

CAUTION

Do not mix new and old batteries.

Make sure to install batteries in correct polarity as indicated in the battery compartment.

If the instrument is powered on, but the display blanks or **BATT** is shown on the lower left corner of the display, replace the batteries .

- Set the Function Selector switch to the "OFF" position.
- Unscrew and remove the battery compartment cover on the bottom of the instrument.
- Replace the batteries observing correct polarity. Make sure to use two new R6P batteries.
- Replace and screw the battery compartment cover.

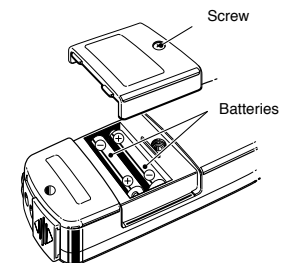

Lifetime Limited Warranty

The attention to detail of this fine snap-around instrument is further enhanced by the application of A.W. Sperry's unmatched service and concern for detail and reliability. These A.W. Sperry snap-arounds are internationally accepted by craftsmen and servicemen for their unmatched performance. All A.W. Sperry's snap-around instruments are unconditionally warranted against defects in material and workmanship under normal conditions of use and service; our obligation under this warranty being limited to repairing or replacing free of charge, at A.W. Sperry snap-around instrument that malfunctions under normal operating conditions at rated use.¹

Replacement procedure

Securely wrap the instrument and its accessories in a box or mailing bag and ship prepaid to the address below. Be sure to include your name and address, as well the name of the distributor, with a copy of your invoice from whom the unit was purchased, clearly identifying the model number and date of purchase.

**A.W.SPERRY INSTRUMENTS INC.
ATT: Customer service dept.
2150 Joshua's Path, Suit 302,
Hauppauge, N.Y. 11788**

¹ The warranty is not applicable if the instrument has been: misused, abused, subjected to loads in excess of specifications, has had unauthorized repair or has been improperly assembled or used.

*Note: Recommended calibration interval should not exceed one year. Calibration service charges are not covered terms and conditions of warranty.